

THIS DRAWING MAY NOT BE USED FOR ANY PURPOSE OTHER THAN BY THE OWNER. THE DRAWING & DESIGN ARE PROPERTY OF ROTONICS MANUFACTURING, INC. ALL DIMENSIONS SHOWN ARE OUTSIDE PART DIMENSIONS IN INCHES, AND MAY VARY DUE TO MATERIAL SHRINKAGE. SPECIFICATIONS ARE SUBJECT TO CHANGE WITHOUT NOTICE. GALLONS AND WEIGHTS ARE APPROXIMATE ONLY.

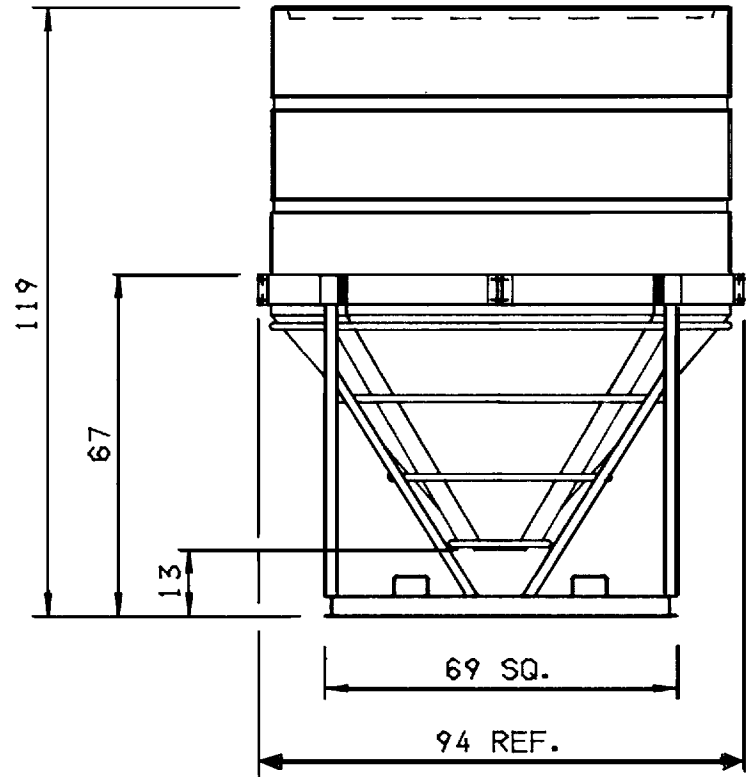
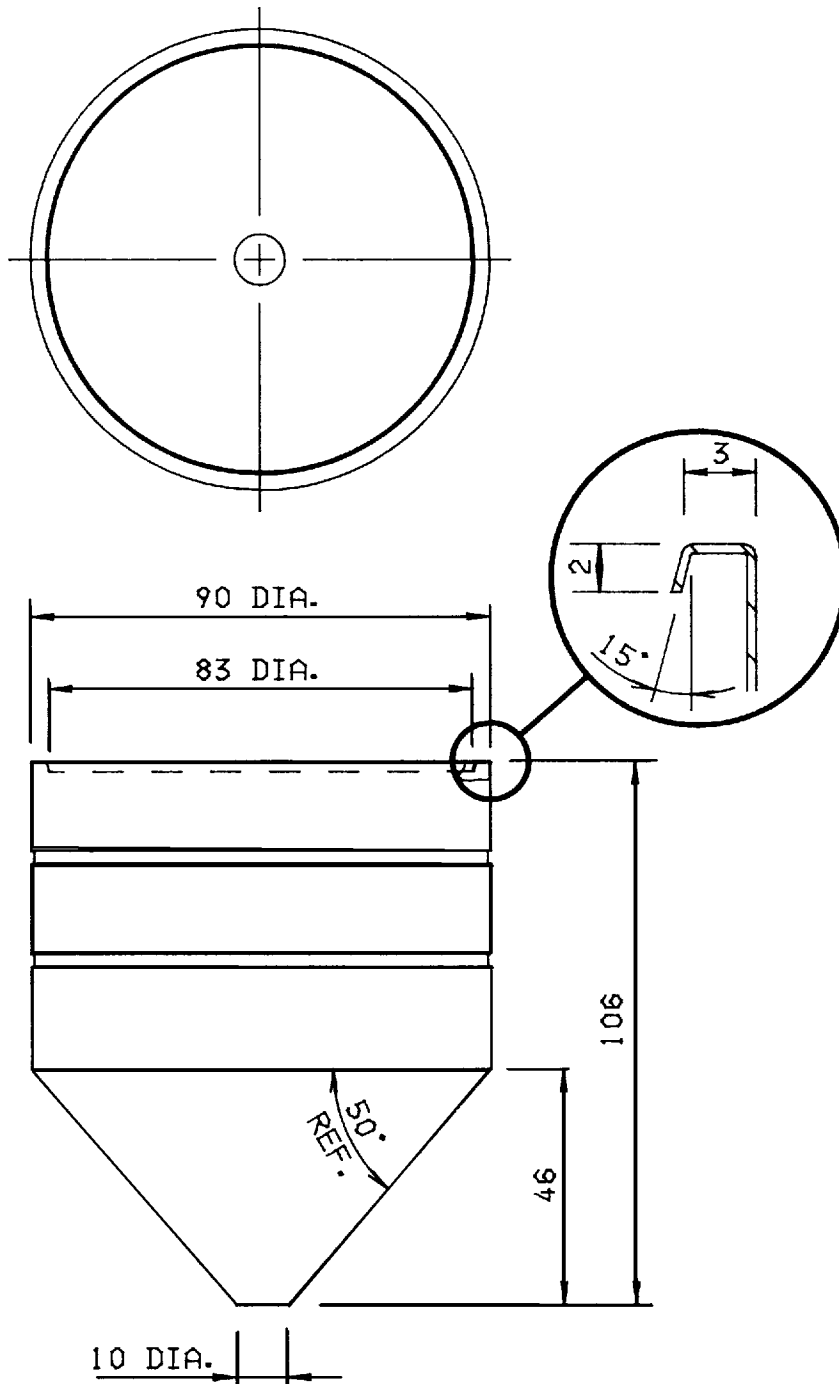

TANK WITH STAND & BASKET

RMI-D
6770 Brighton Blvd.
Commerce City, CO 80022
Phone: 303-227-9300
Fax: 303-227-9308

RMI-G
17038 S. Figueroa St.
Gardena, CA 90248
Phone: 310-327-5401
Fax: 310-323-9567

ROTONICS MFG. INC.

#6511

90" DIA. - 2175 GAL.
OPEN TOP CONE BOTTOM TANK

DRAWN BY:
Dpham

DESIGN BY:

DATE:
09-23-96

SCALE :
NONE

DWG. NO.
S-1300