

THIS DRAWING MY NOT BE USED FOR ANY PURPOSE OTHER THAN BY THE OWNER. THE DRAWING & DESIGN ARE PROPERTY OF ROTONICS MANUFACTURING, INC. ALL DIMENSIONS SHOWN ARE OUSIDE PART DIMENSIONS IN INCHES, AND MAY VARY DUE TO MATERIAL SHRINKAGE. SPECIFICATIONS ARE SUBJECT TO CHANGE WITHOUT NOTICE. GALLONS AND WEIGHTS ARE APPROXIMATE ONLY.

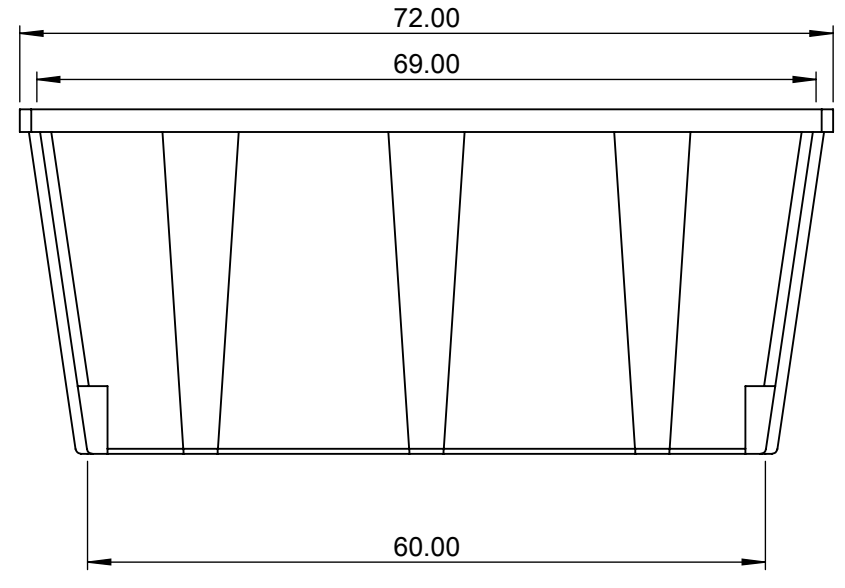
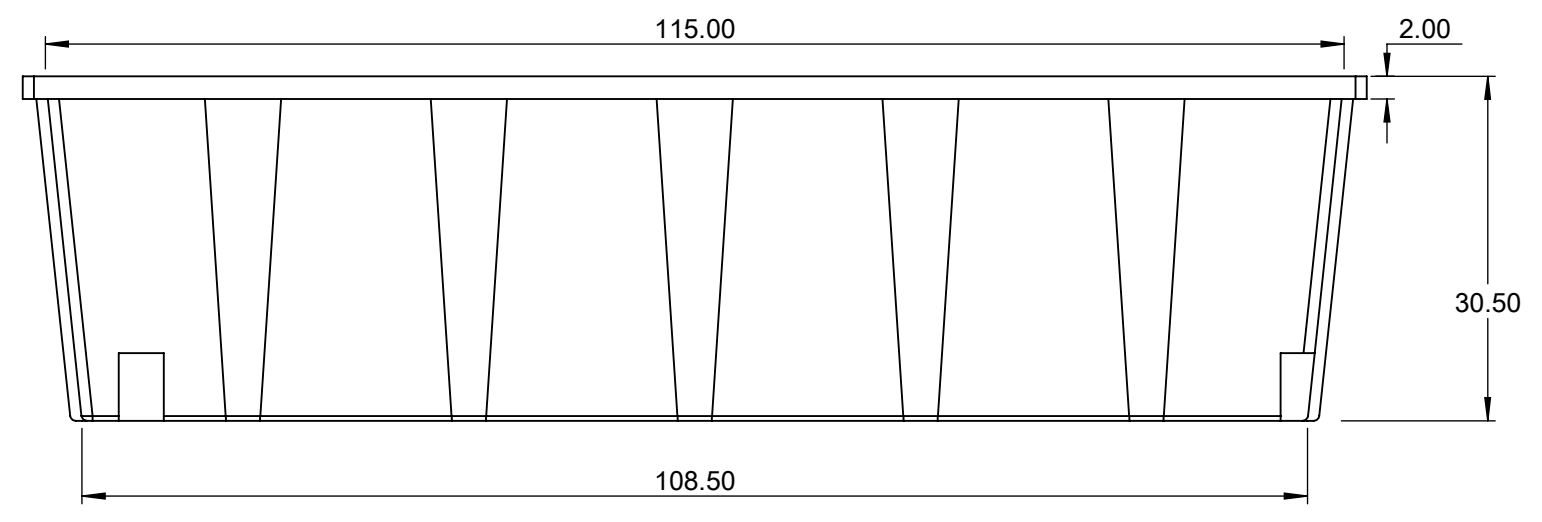
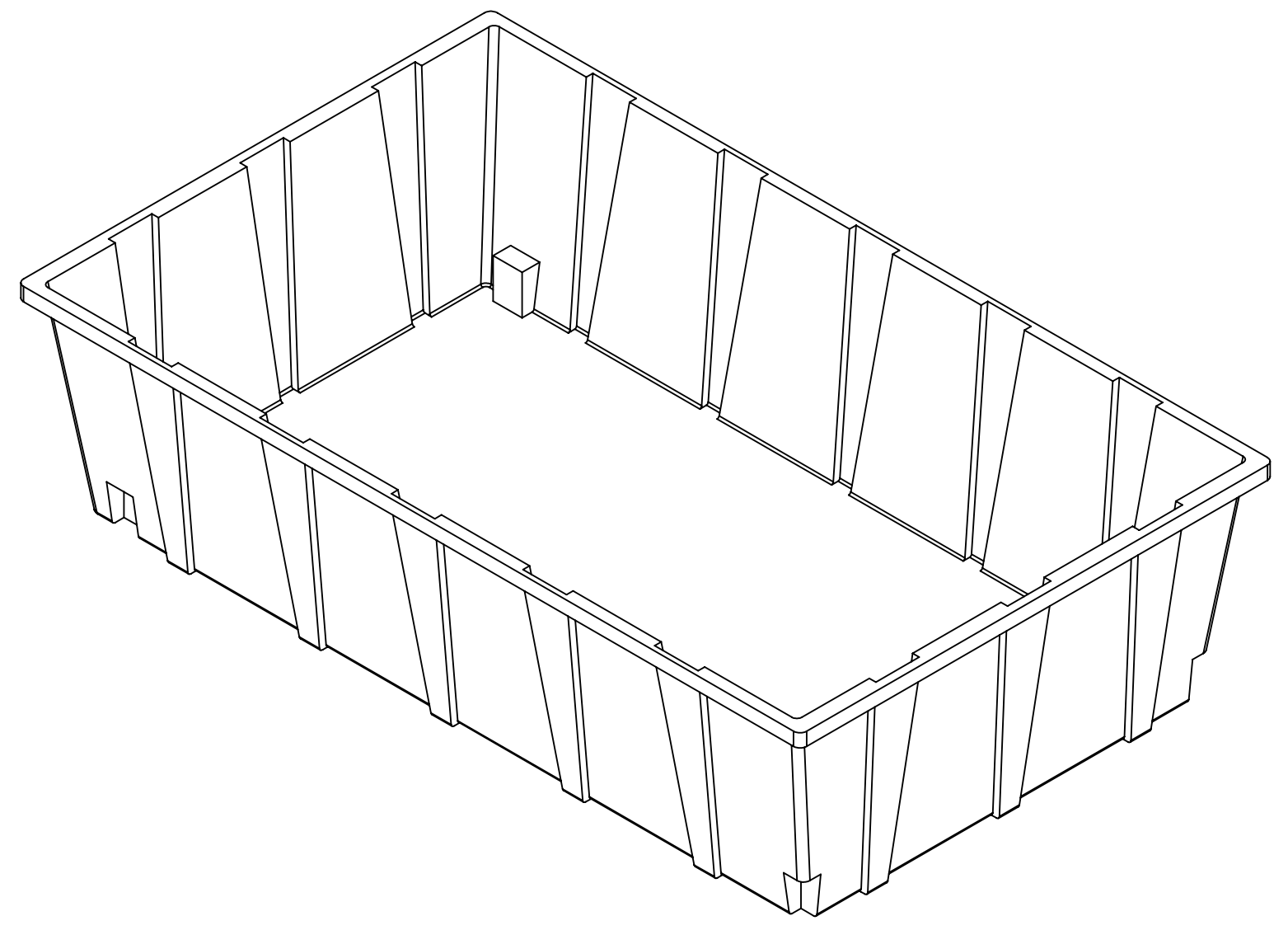
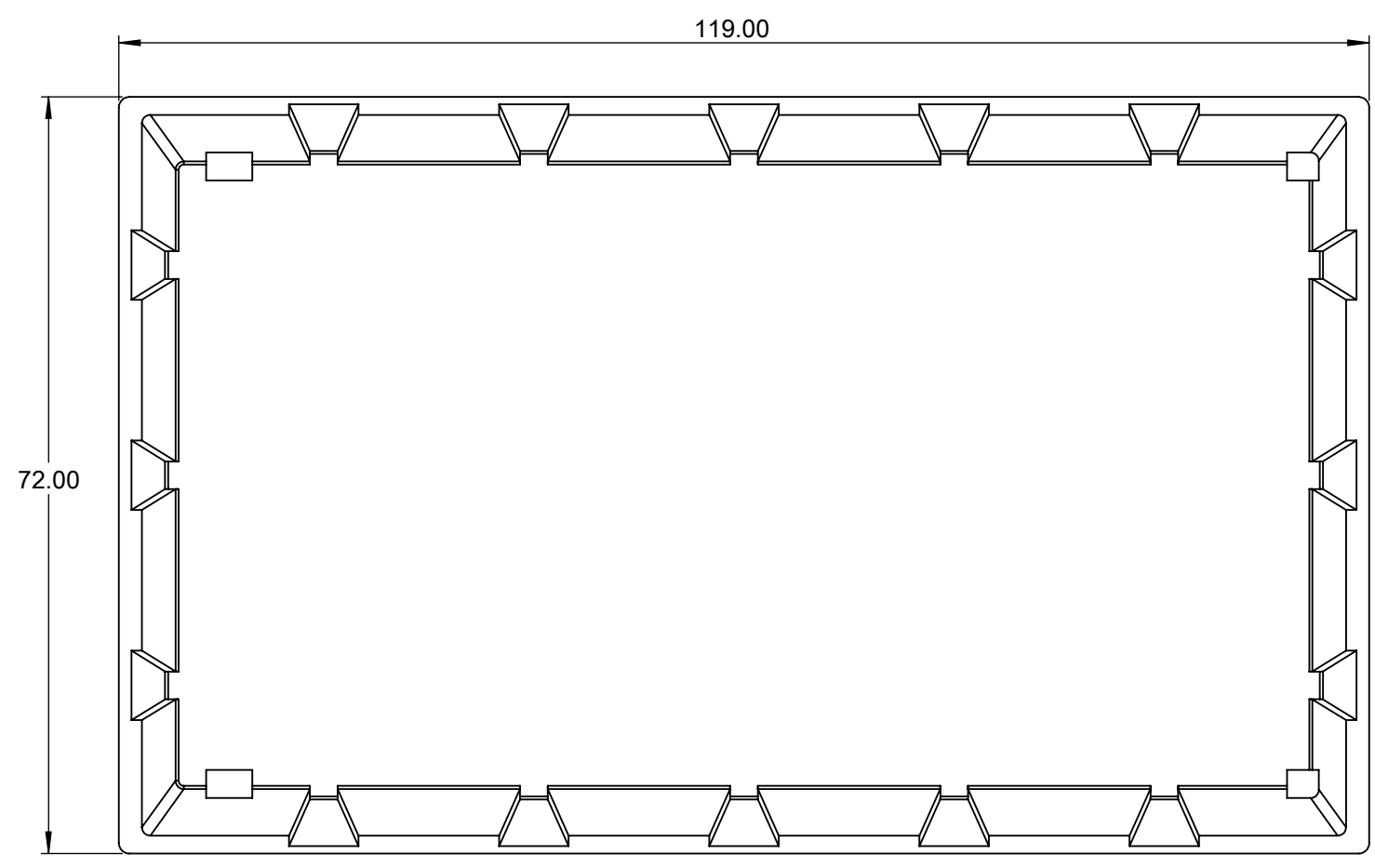

ROTONICS MFG, INC. www.rotomics.com		RMI-G 17038 S. Figueroa St. Gardena, CA 90248 Phone: 310-327-5401 Fax: 310-323-9567	
TITLE: 6611		950 GALLON CHEMICAL CONTAINMENT BASIN 3	
DRAWN BY: S CAMPBELL	DATE: 08/21/09	DWG. NO. 6611	REV: A
SCALE: 1:17		SHEET 1 OF 1	